

## INSTRUCIUNI DE ASAMBLARE PENTRU MONTAREA PE TAVAN A SUPORTULUI DE PROIECTOR

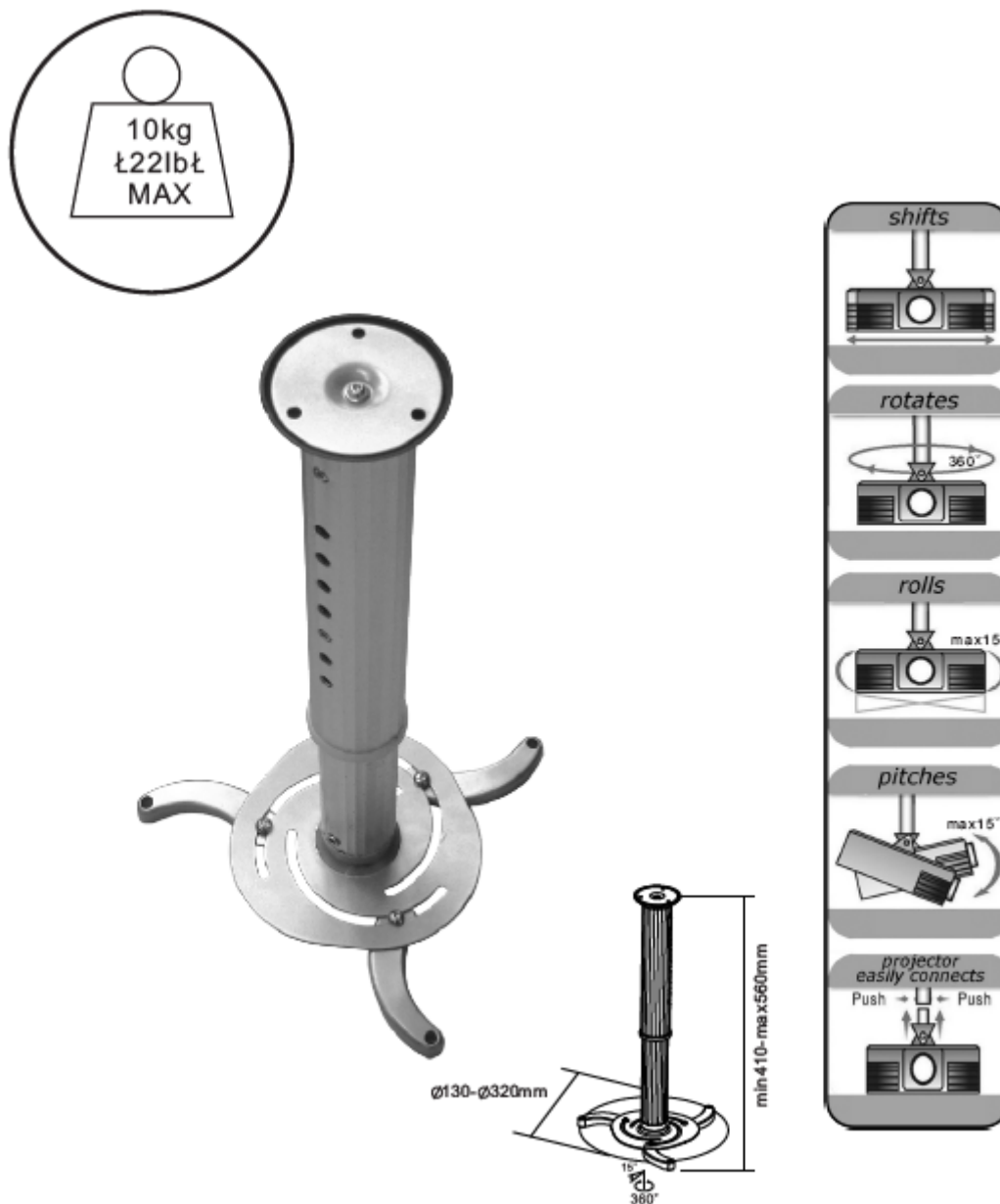





















Acest produs este conceput pentru montarea pe tavan a videoproiectoarelor cantarind pana la max. 10 kg.

**OBSERVATII - AVERTISMENT:** Asigurati-va ca nu exista componente lipsa sau parti defecte. Nu folositi componentele defecte. Instalarea necorespunzatoare poate cauza deteriorarea produselor sau raniri grave.

**Nota:** Componentele incluse servesc pentru montarea pe pereti din beton sau lemn masiv. Daca nu sunteti siguri in ceea ce priveste rezistenta peretelui, consultati un expert pentru montarea corespunzatoare pe alte tipuri de pereti. Componentele furnizate nu sunt pentru montare pe suprafete metalice sau pereti cu lambriuri de plastic.

**COMPONENTE:**

Parts	Picture	Standard package	Parts	Picture	Standard package
1. Placa de tavan		x1	12. Imbus 5 mm		x1
2. Placa proiector		x1	13. Imbus 4 mm		x1
3. Tub extensie 30cm		x1	14. Surub diblu 6 mm		x3
4. Tub extensie 25cm		x1	15. Diblu beton		x3
5. Brat proiector		x3	16. Saibe M6		x6
6. Garnitura cauciuc		x1	17. Surub cu piulita		x3
7. Surub M6		x4	18. Surub M6		x4
8. Surub M4		x4	19. Garnitura cauciuc		x1
9. Element reglaj		x2	20. Conector plastic		x1
10. Element reglaj		x3			
11. Saibe M6		x3			

**1. MONTARE VIDEO PROIECTOR**

**a. montaj uzual**



Fixati bratul proiector(5) cu suruburile (17)

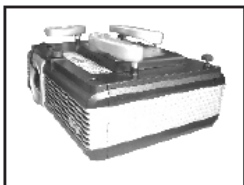

Reglati bratele (5) la acelasi nivel

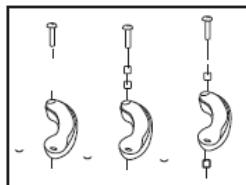

Alegeti una din metodele din figura pentru reglaj planeitate



Fixati placa proiector cu suruburile (7), saibe (11) si saibe (16)

**b. montaj special (pentru proiectoare Toshiba)**



Atasati elementele reglaj (9) la video proiector utilizand suruburile M4 (8)

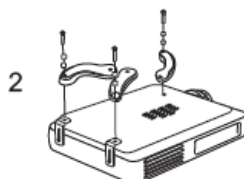

Fixati placa proiector utilizand suruburile (17)

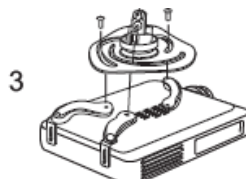

Fixati placa proiector cu suruburile (7), saibe (11) si saibe (16)



Strangeti suruburile

**c. montaj special (pentru proiectoarele Philips)**

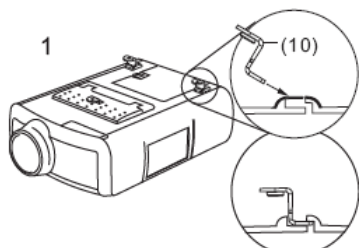

Atasati elementele de reglaj (10)

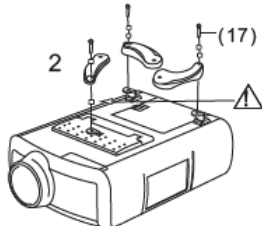

Fixati bratele proiector (5) utilizand suruburile (17)

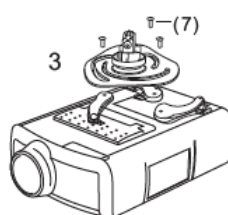

Fixati placa proiector cu suruburile (7), saibe (11) si saibe (16)

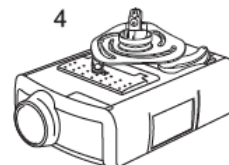

Strangeti suruburile

## 2. MONTAREA PE TAVAN

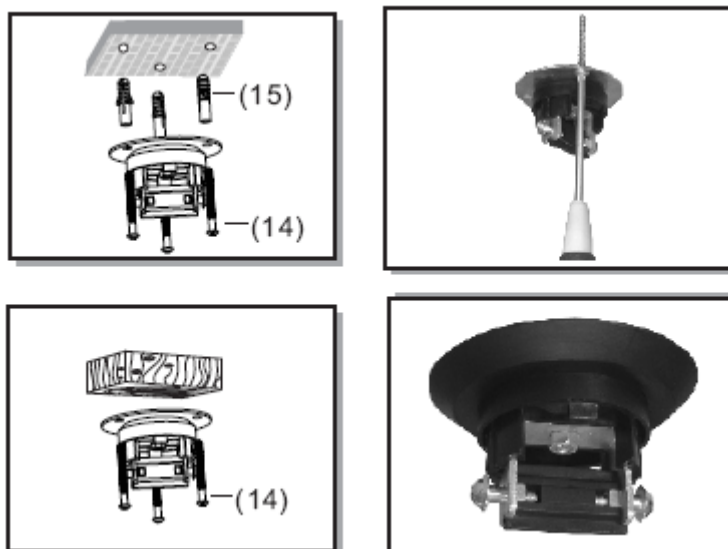

Folositi *PLACA DE TAVAN* (1) ca model pentru a marca 3 locuri de amplasare a gaurilor in perete. Gauriti cu un burghiu de zidarie cu diametru de 8 mm la cel puțin 50mm adancime si introduceti diblurile (15) in fiecare din aceste gauri. Fixati *PLACA DE TAVAN* (1) pe perete folosind cele 3 suruburi pentru dibluri(14) si saibele (16). Pentru montarea pe pereti din lemn, se respecta aceiasi pasi, singura diferenta constand in faptul ca gaurile pentru suruburile de prindere sunt de 3 mm si nu se mai folosesc diblurile de beton.

### IMBINARE

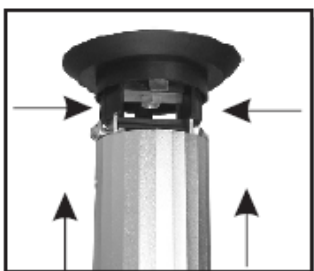

Imbinati tubul de extensie (3) cu placa de tavan si impingeti cele 2 bolturi simultan



Rasuciti bolturile in afara pentru siguranta maxima utilizand cheia imbus (13)

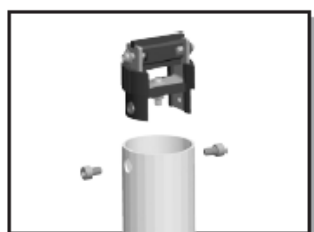

Imbinati conectorii din plastic (20) la tubul de extensie (4) utilizand 2 suruburi M6 (18)

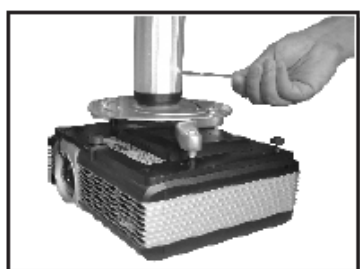

Imbinati placa proiector (2) cu tubul de extensie (4) utilizand 2 suruburi M6 (18)



Imbinati tuburile de extensie (4) cu tuburile de extensie (3) impingand cele 2 bolturi simultan si apoi impingeti garnitura de cauciuc in tuburile de extensie (3)

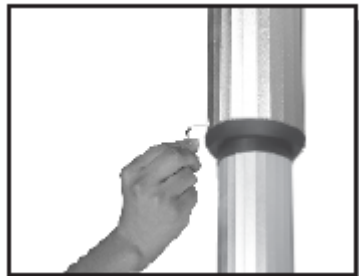

Rasuciti bolturile in afara pentru siguranta maxima utilizand cheia imbus (13)

## REGLAJ



Pozitionati proiectorul in pozitia dorita prin actionarea asupra placii proiecteurului